

# Measuring Guide

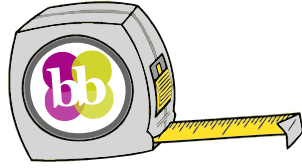

Measuring for your new blinds is really simple and straightforward, just see the guides below. We recommend that you use a steel tape measure for accuracy (cloth ones tend to stretch) and have a pencil and pad handy. Remember that the only real difference between a recess or an exact fitting is that if you specify recess fitting we will make the appropriate adjustments to the sizes to ensure a perfect fit.

## Measuring outside the recess

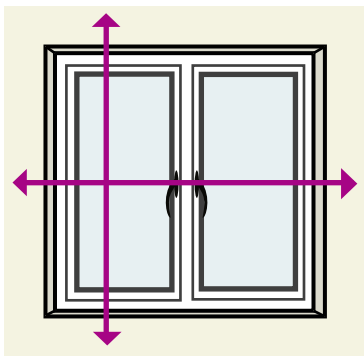

**1\***. Decide how much you want to overlap the blind on all sides of the window - we recommend this should be at least 50mm (2 inches) each side in most instances.

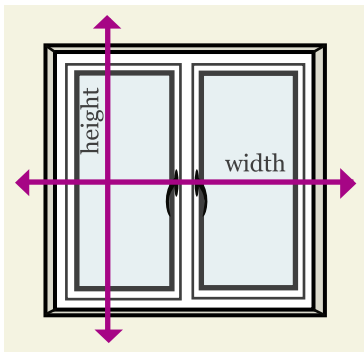

**2\***. Carefully measure the width and the drop in several places and note down the smallest measurements to the nearest millimetre.

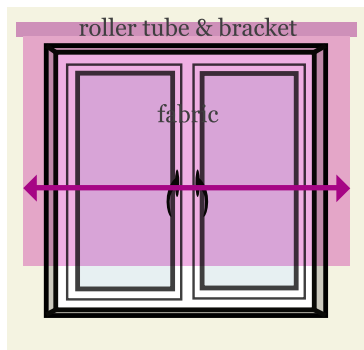

**3.** We will make the blinds to fit exactly to your requirements. (Exact)

## \* Important Information

Remember on roller blinds the fabric will be approximately 35mm less than the overall width so you must allow for this.

If you are measuring an existing blind that's fine but don't get caught out with roller blinds. On a roller blind the fabric is always approximately 35mm less than the "true" blind size (the blind size being bracket to bracket). Please don't just measure the fabric on a roller blind you will end up with a blind too narrow!

## Measuring inside the recess

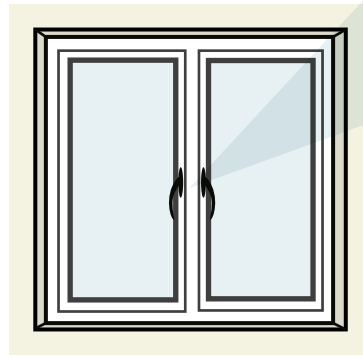
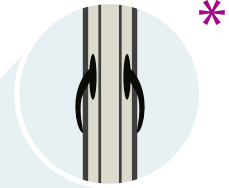

**1\***. First ensure that the window recess your blind is going into is not obstructed in any way so the blind can hang freely when fully extended. \*Look out for protruding window handles and tiles.

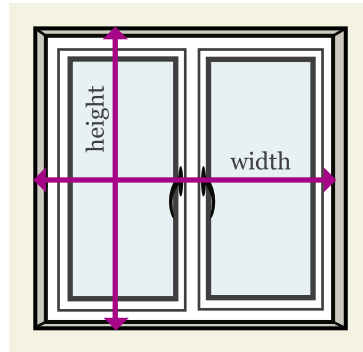

**2\***. Measure the width and drop. We recommend you do this in several places to allow for any slight size variation and note down the smallest measurements to the nearest millimetre.

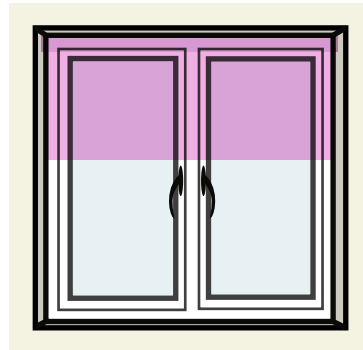

**3.** We will make your blind to fit into the recess perfectly. There is no need for you to make any adjustments. (Recess)

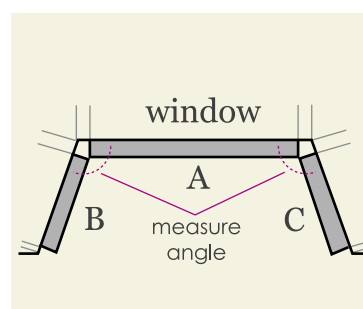

## Bay Windows

Due to the many different types of bay windows and the different ways that blinds can be fitted we suggest sending our customer service team an email for expert advice. Always include a photo/drawing of your bay window and supply approximate measurements.